

980340

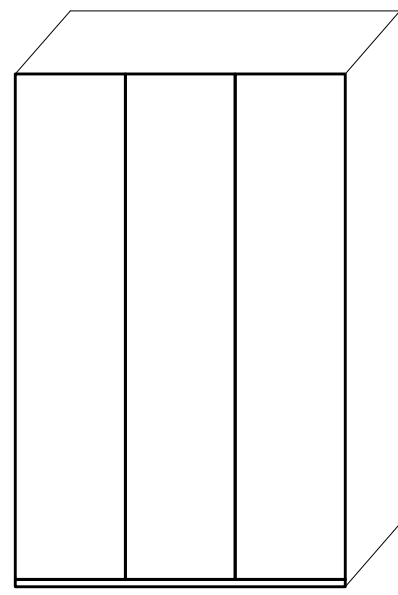

NSP 135

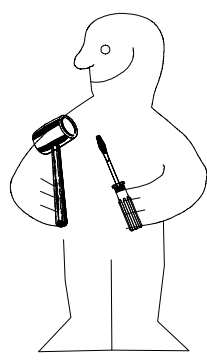
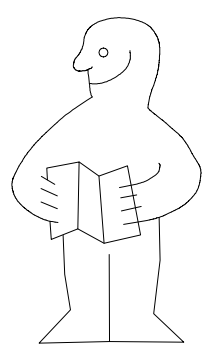
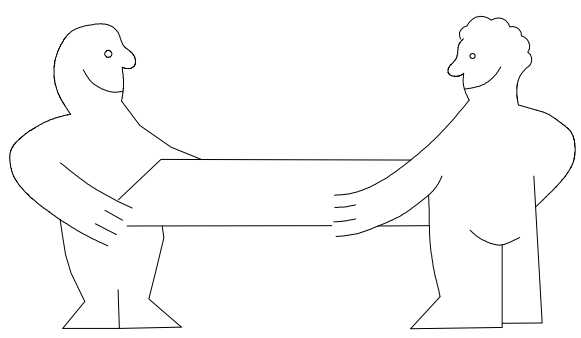
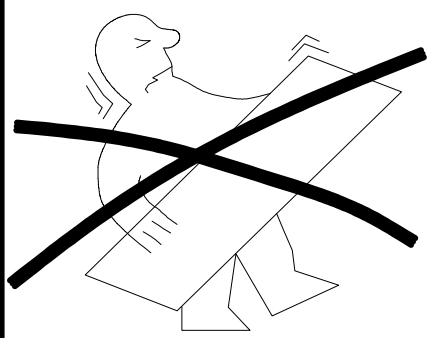

1-2-3-4... ○

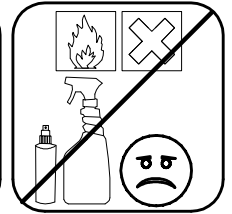
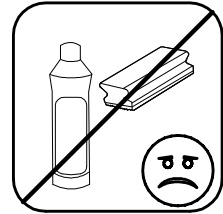
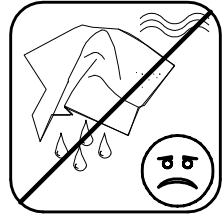
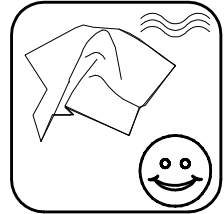
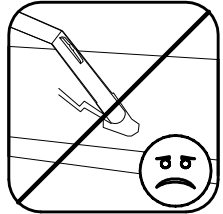
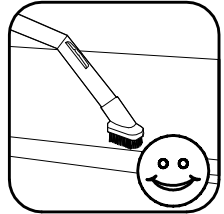
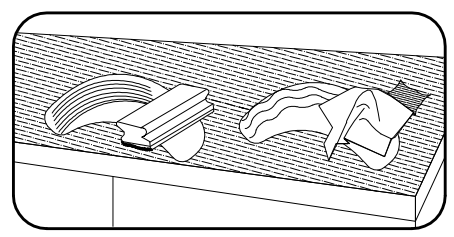
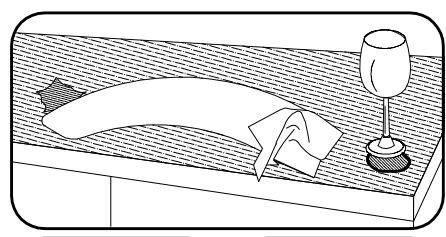
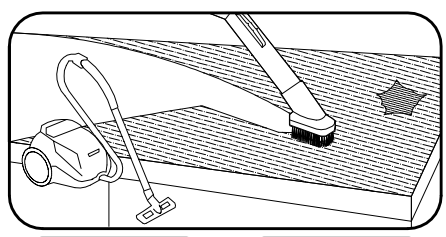
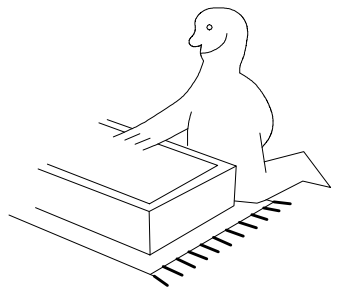
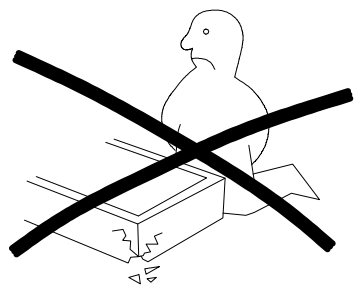
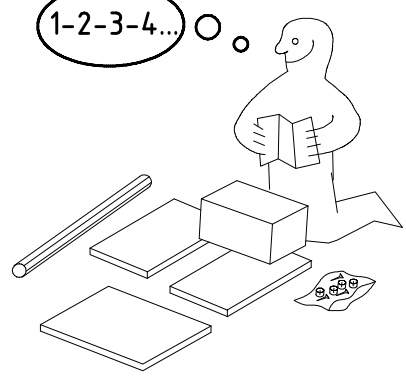









980340

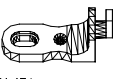

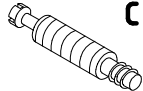

12.04.11 / 02.04.12

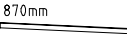
04 12

1/8

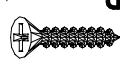
 111 102	A 12x
 111 610	L7 8x
 111 174	J1 4x
 117 001	K1 4x

 111 103	C 12x
 M6 x 11 mm 121 181	T6 4x
 870mm 112 402	K20 1x
 424mm 112 403	K21 1x

 3,5 x 35 mm 121 375	G14 6x
 112 268	M 9x
 112 267	N 9x
 3,5 x 15 mm 121 370	G1 8x

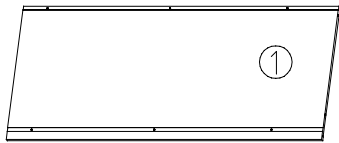
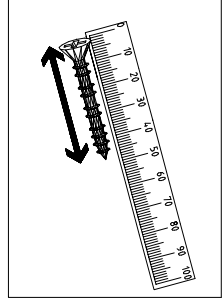
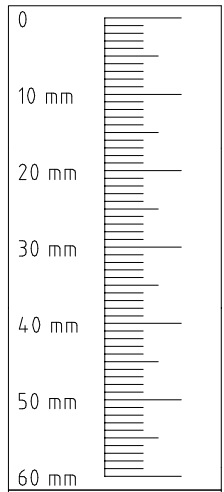
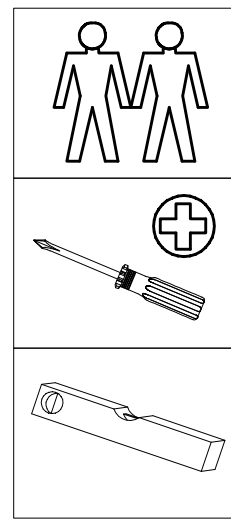

1317x560x15

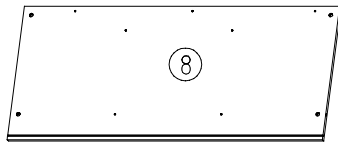

1317x560x15

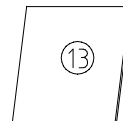

429x500x18

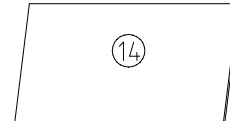

873x500x18

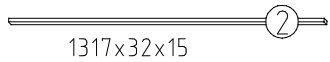

1317x32x15

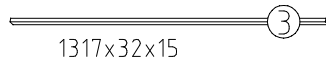

1317x32x15

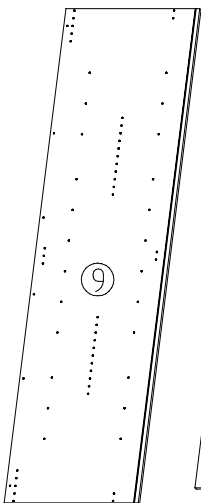

2064x560x15

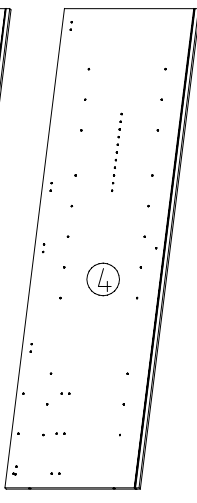

2001x560x15

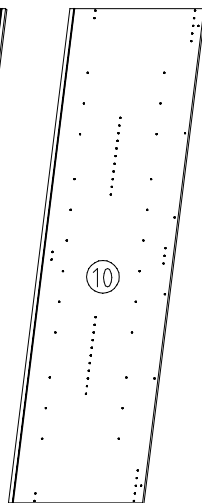

2064x560x15

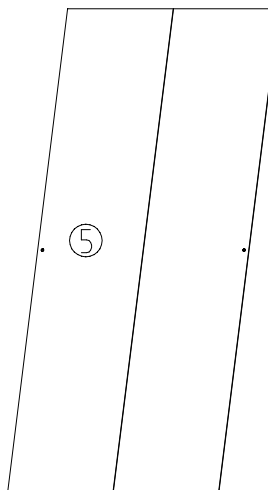

2015x882x2,5

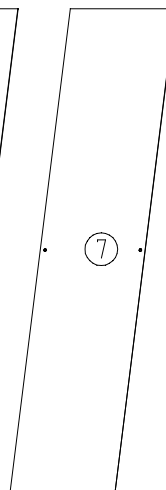

2015x438x2,5

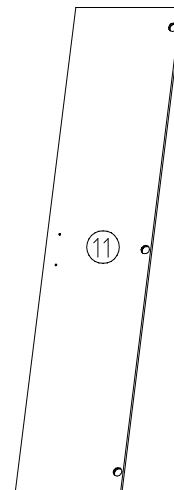

2021x439x15

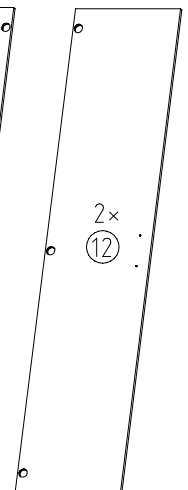

2x
12

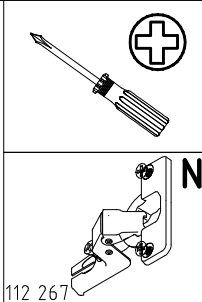
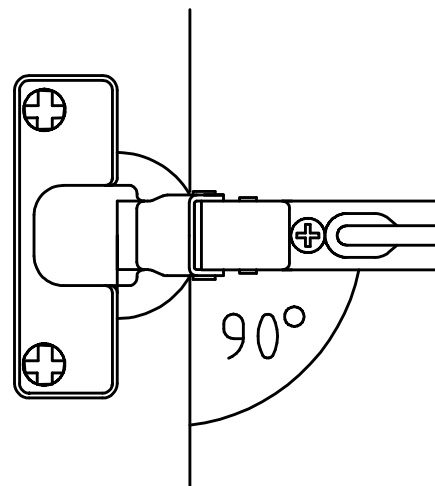
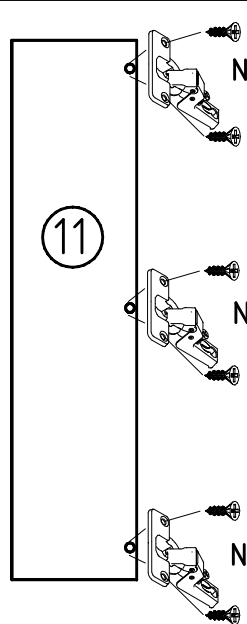
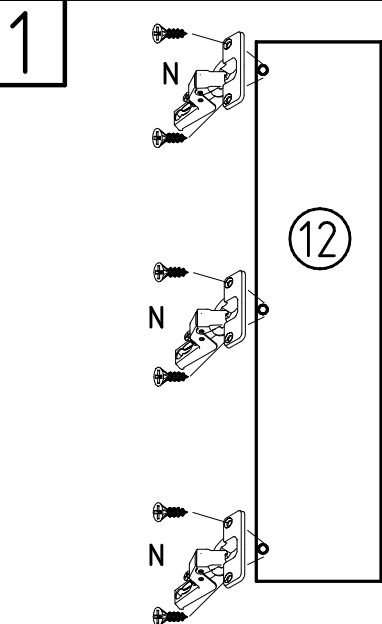

2

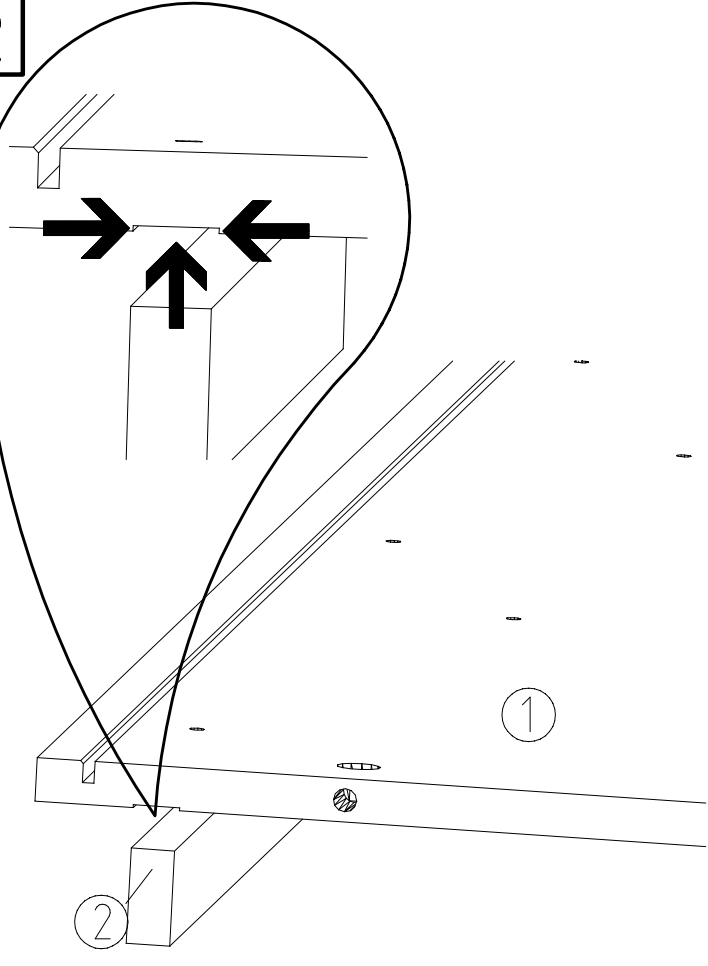

3

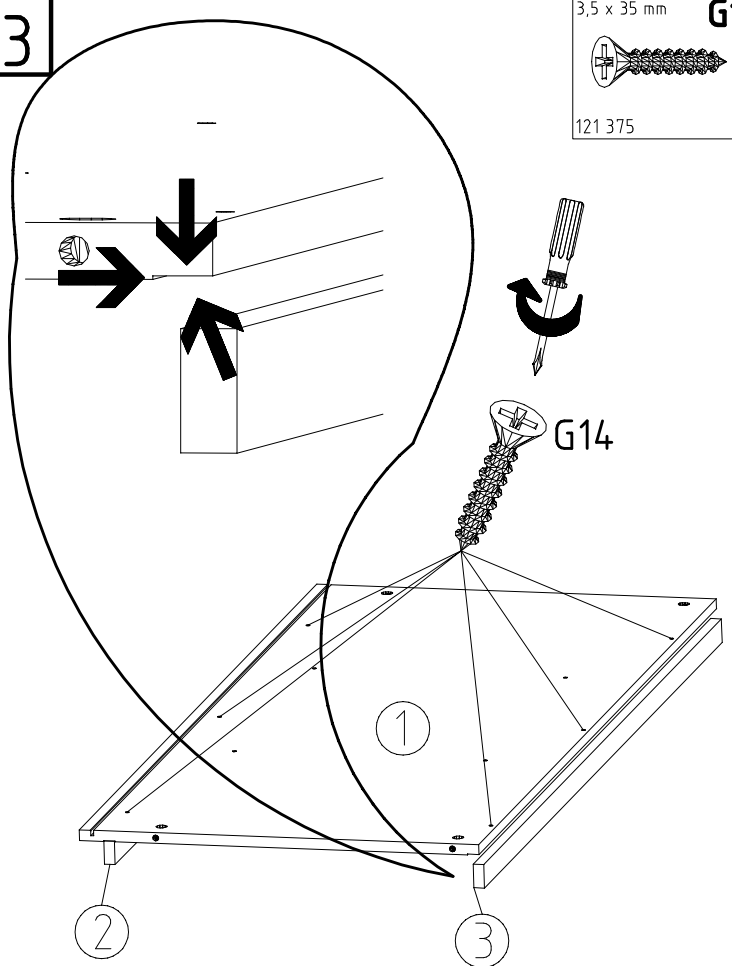





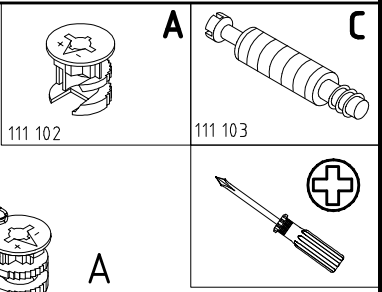
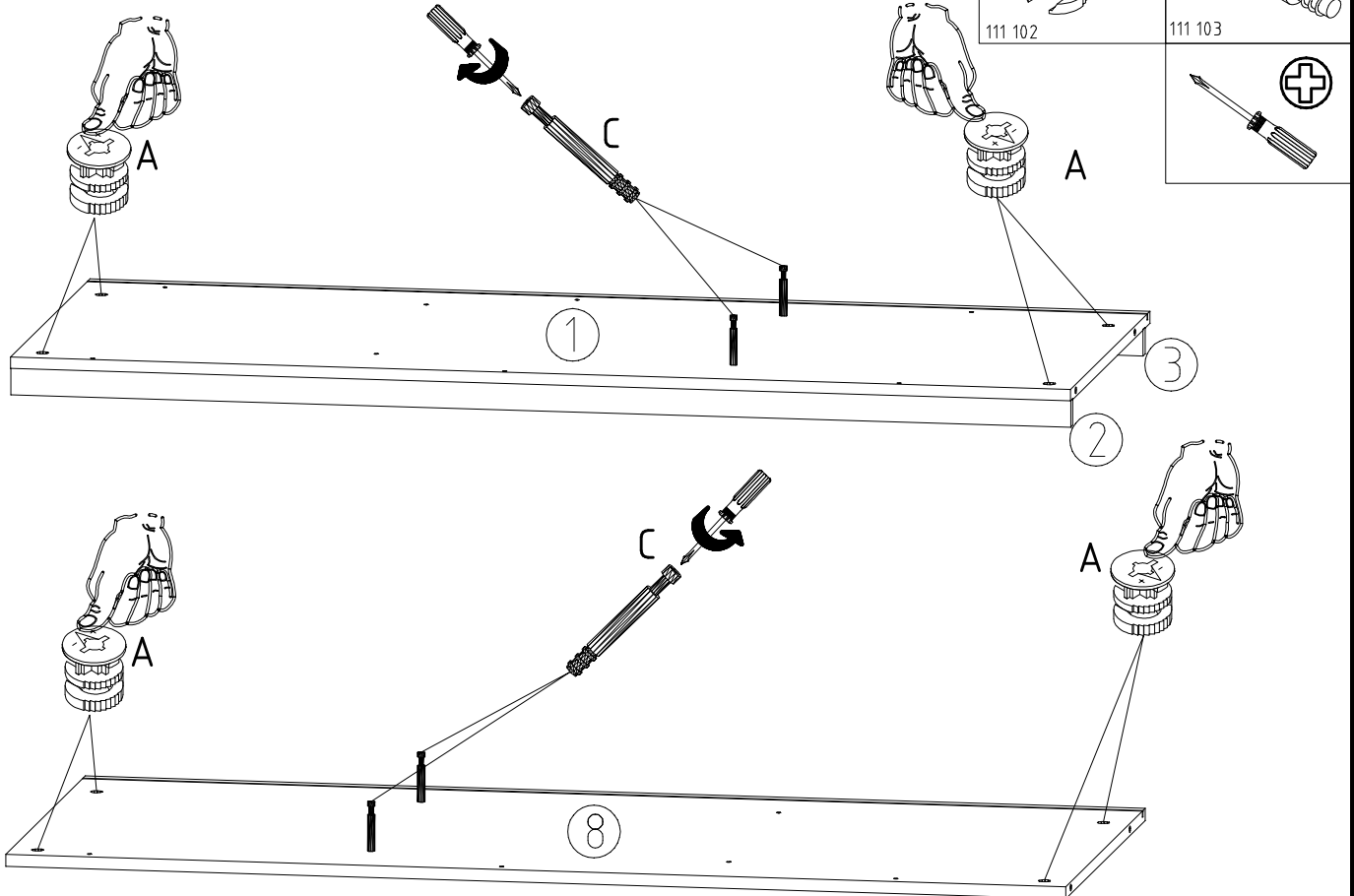
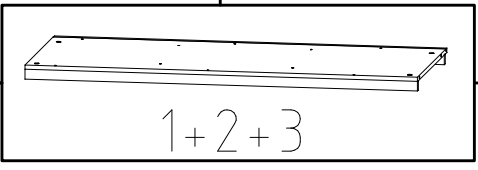

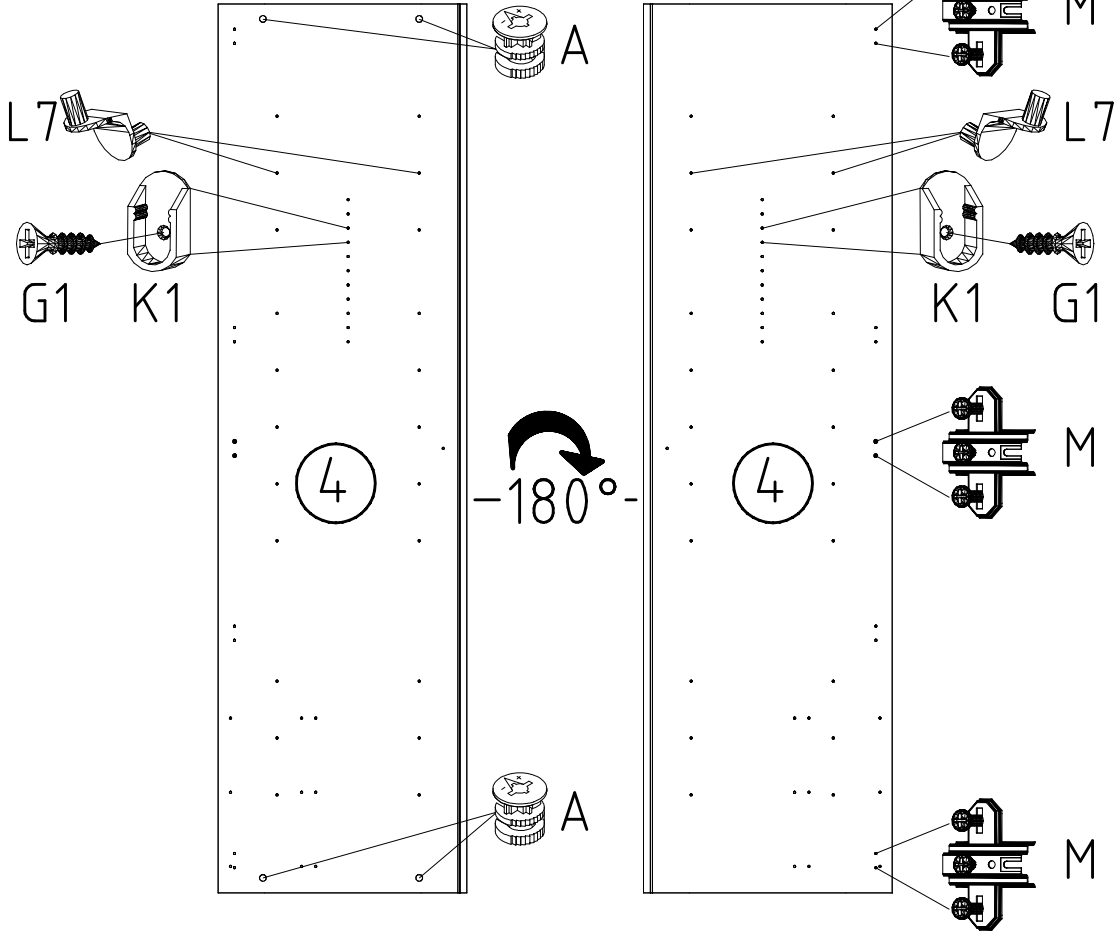

3,5 x 35 mm **G14**

 121 375

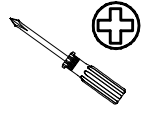
4



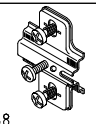





5

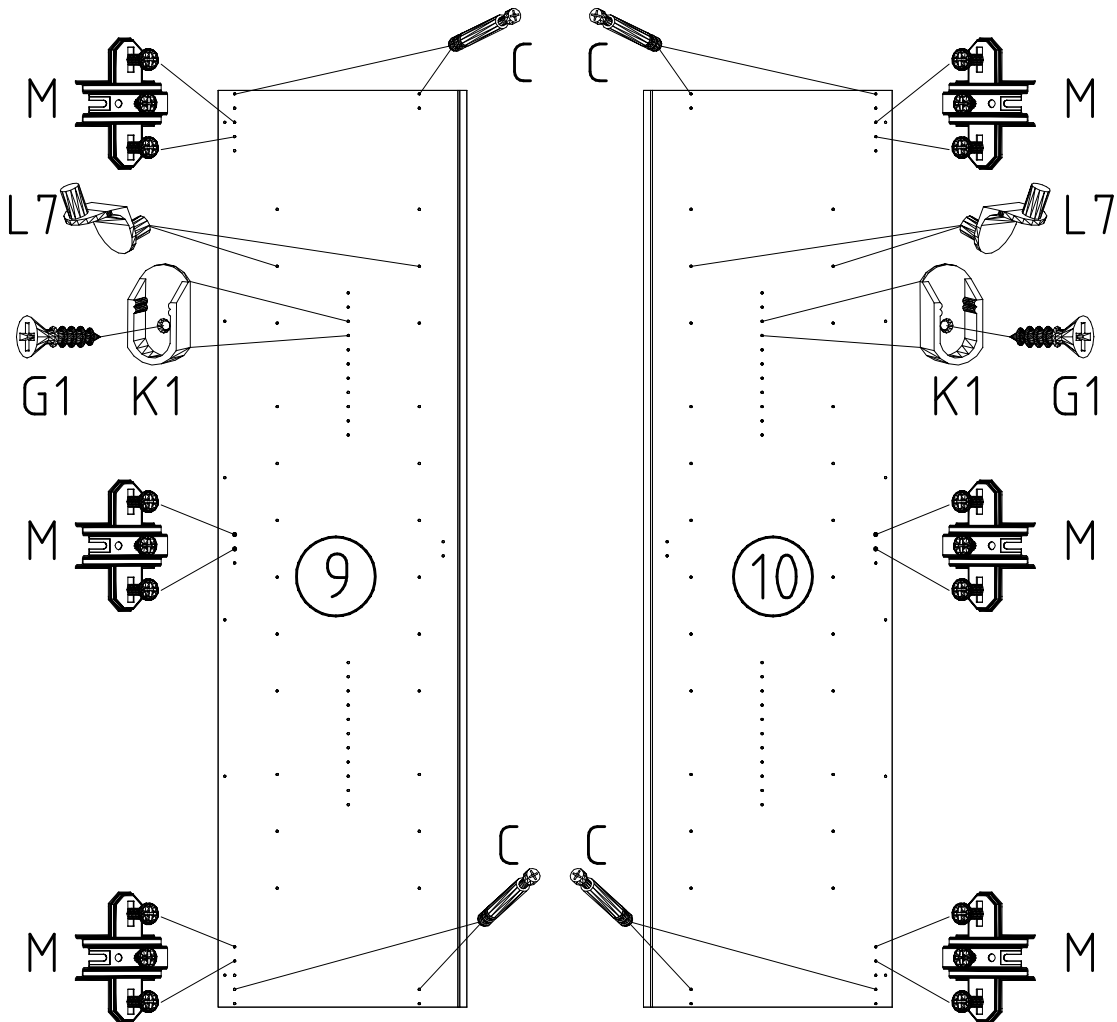

-  L7
111 610
-  
- 3,5 x 15 mm **G1**
 121 370
-  **A**
111 102
-  **M**
112 268
-  **K1**
117 001

6

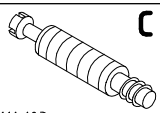
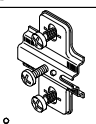

-  L7
111 610
-  
- 3,5 x 15 mm **G1**
 121 370
-  **C**
111 103
-  **M**
112 268
-  **K1**
117 001

7

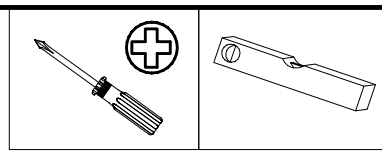
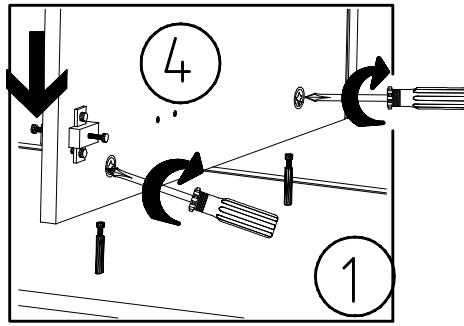
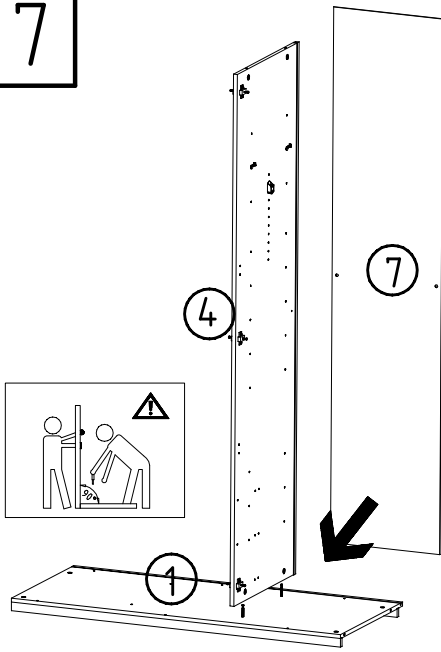

8

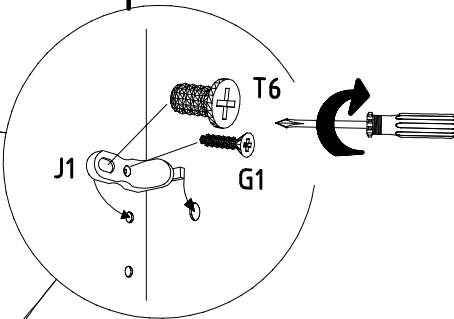
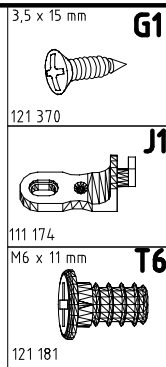
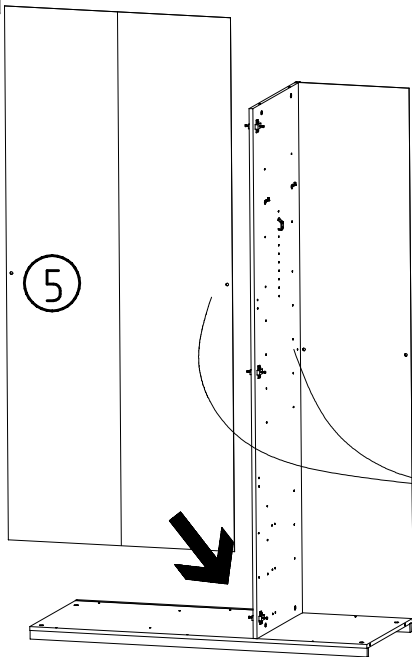

9

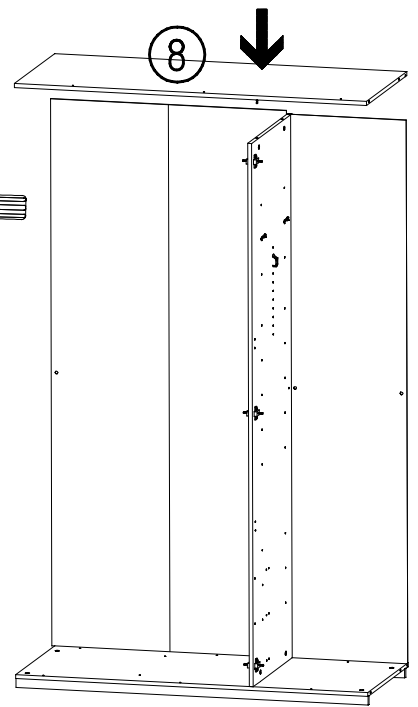
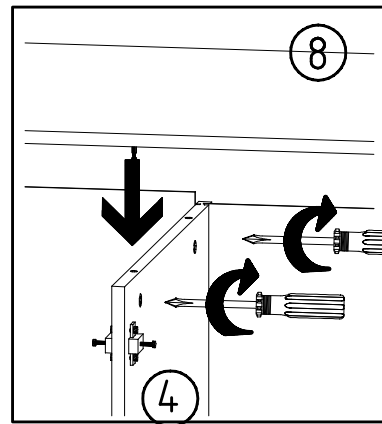

10

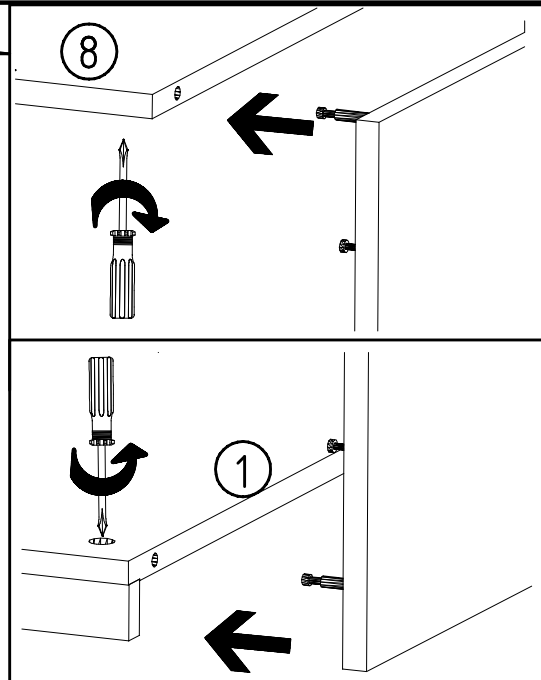
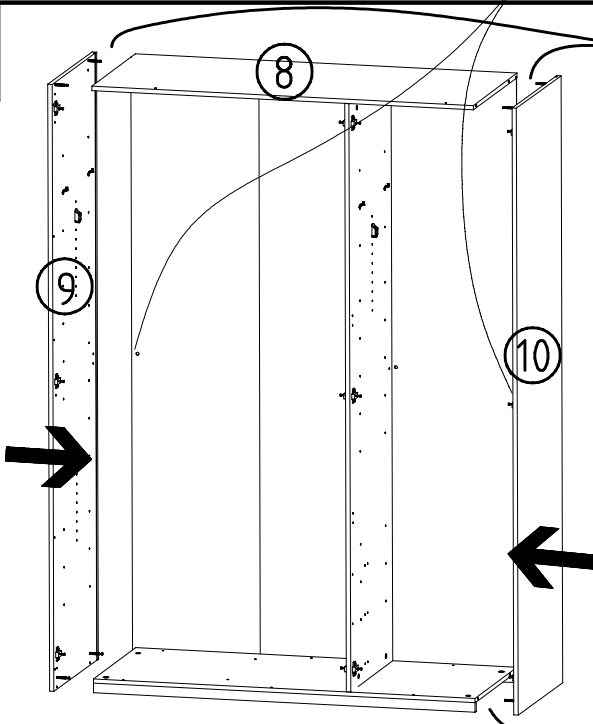

11

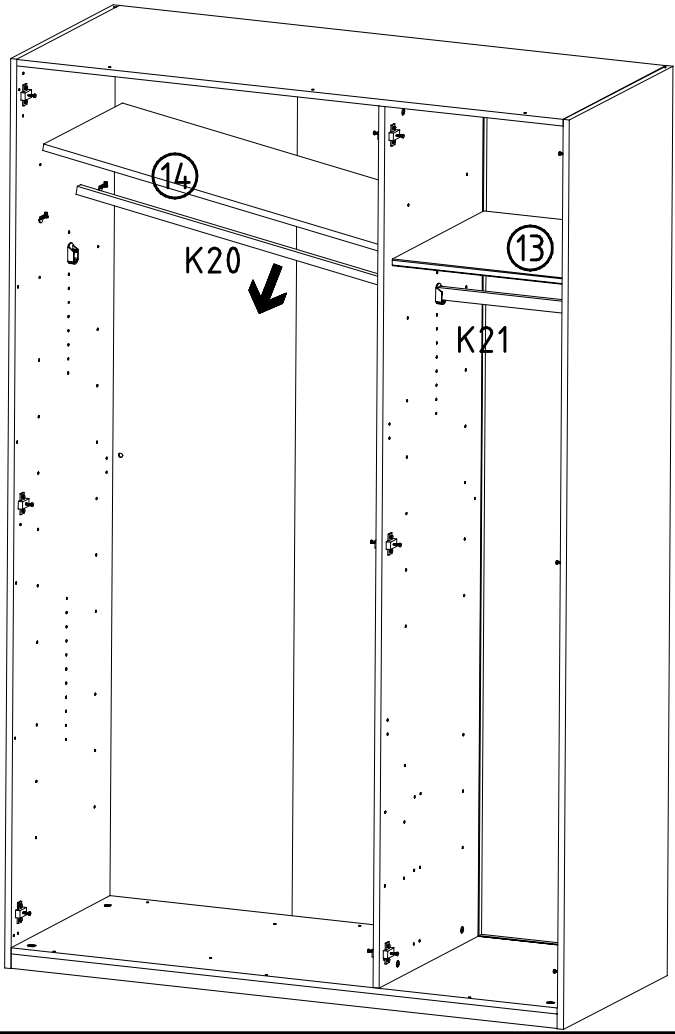

	K20
870mm	
112 402	
	K21
424mm	
112 403	

12

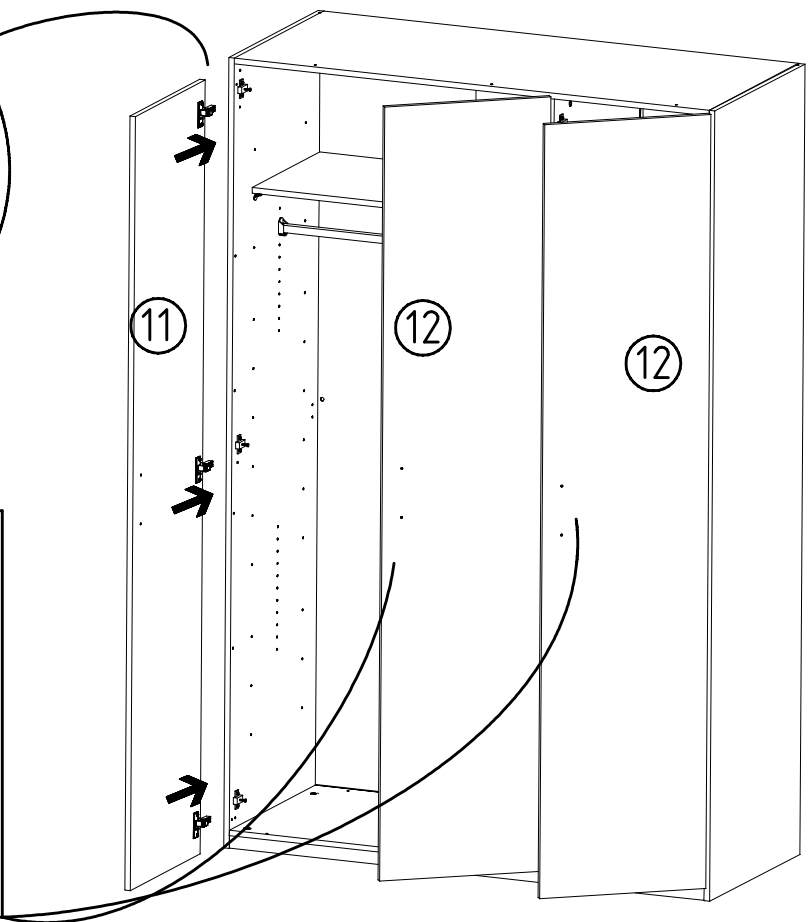
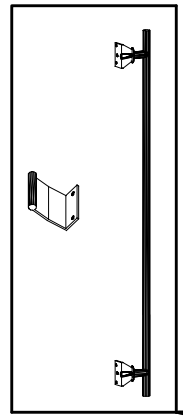
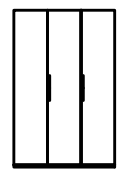
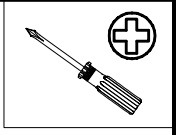
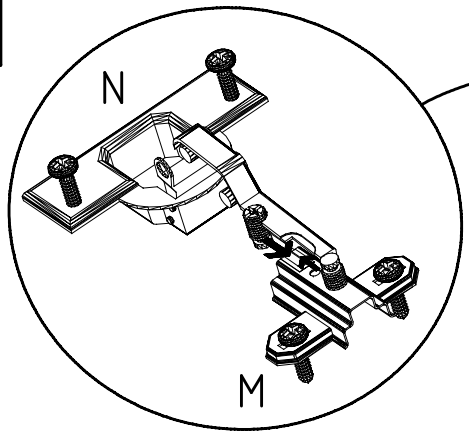

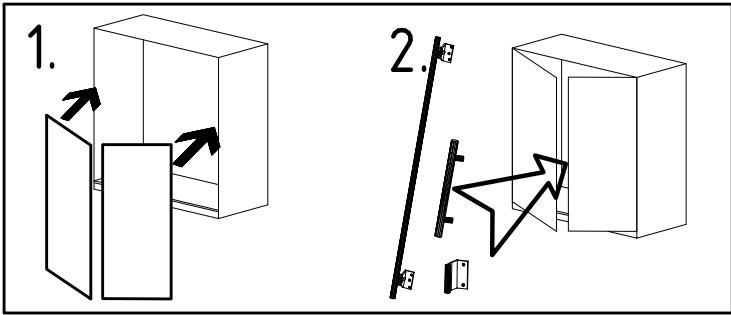
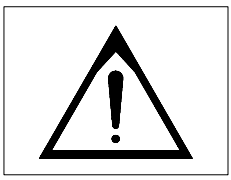

3,5 x 15 mm 121 370	G1	4,0 x 12 mm 122 625	G56
------------------------	----	------------------------	-----

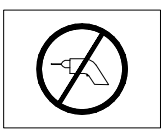
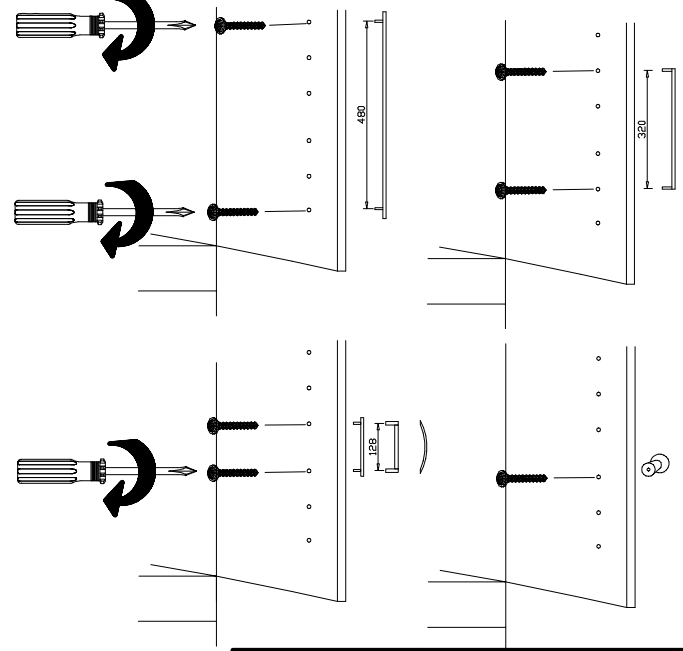
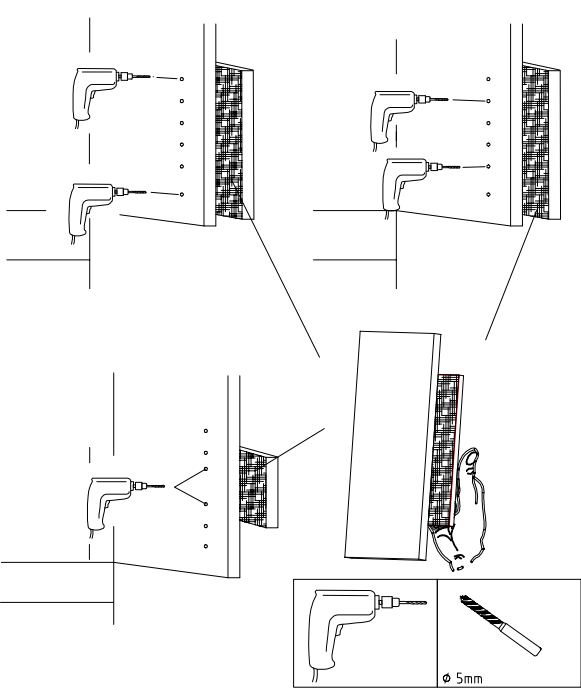
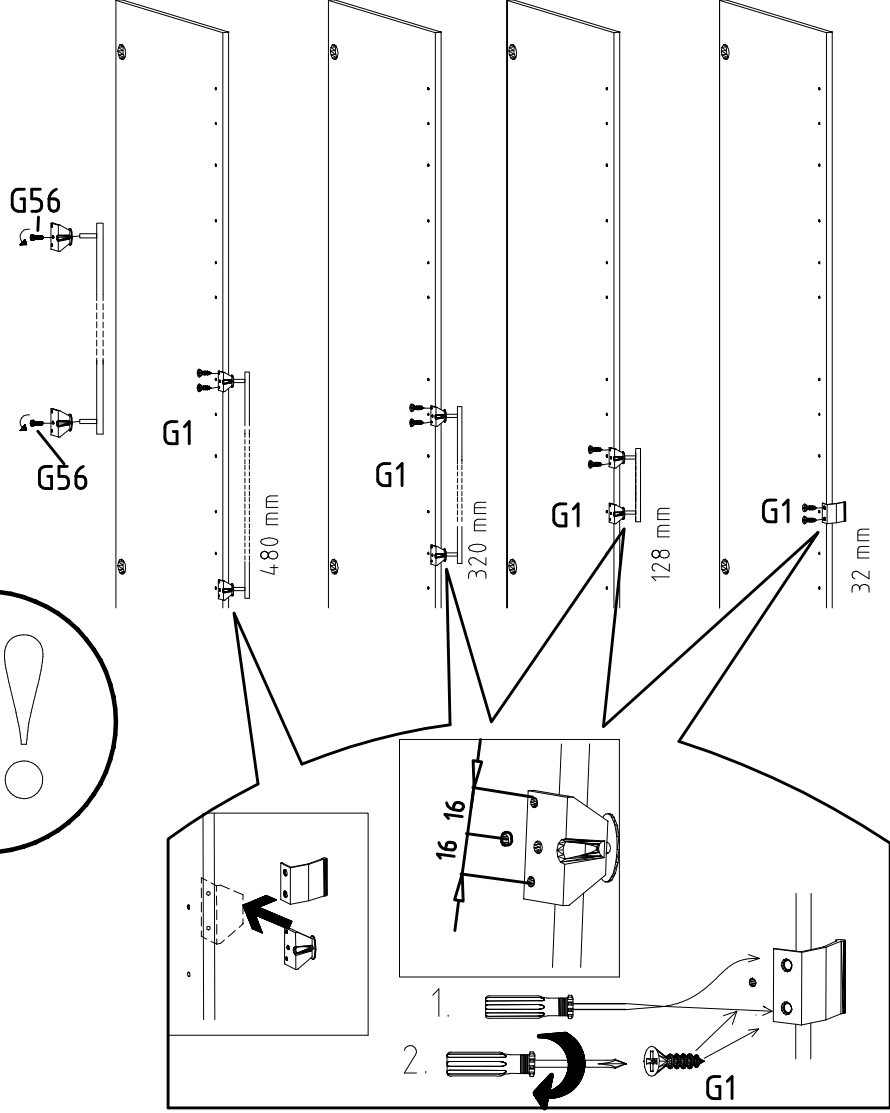
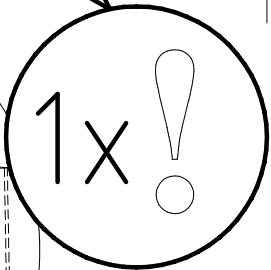
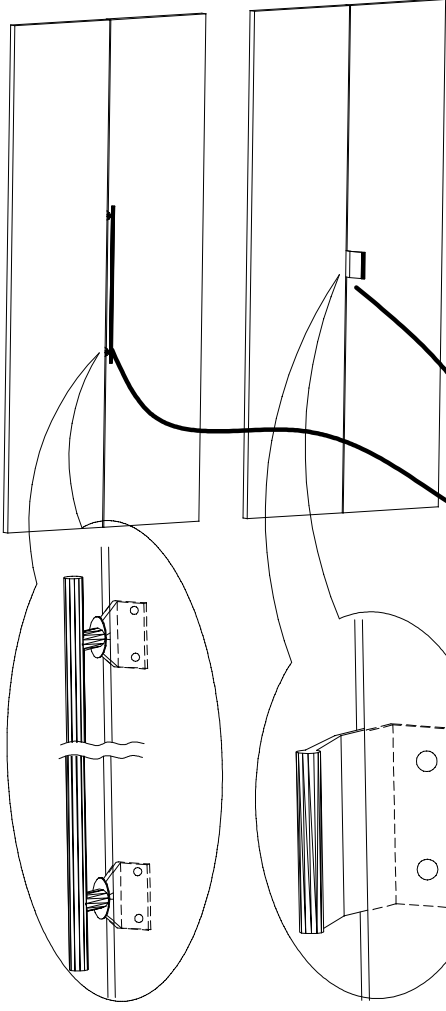

SP27 4 X 27mm 122620 4,0x22 122 609	G49
---	-----

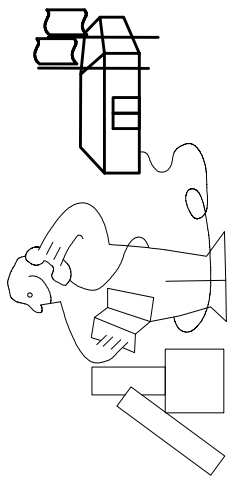
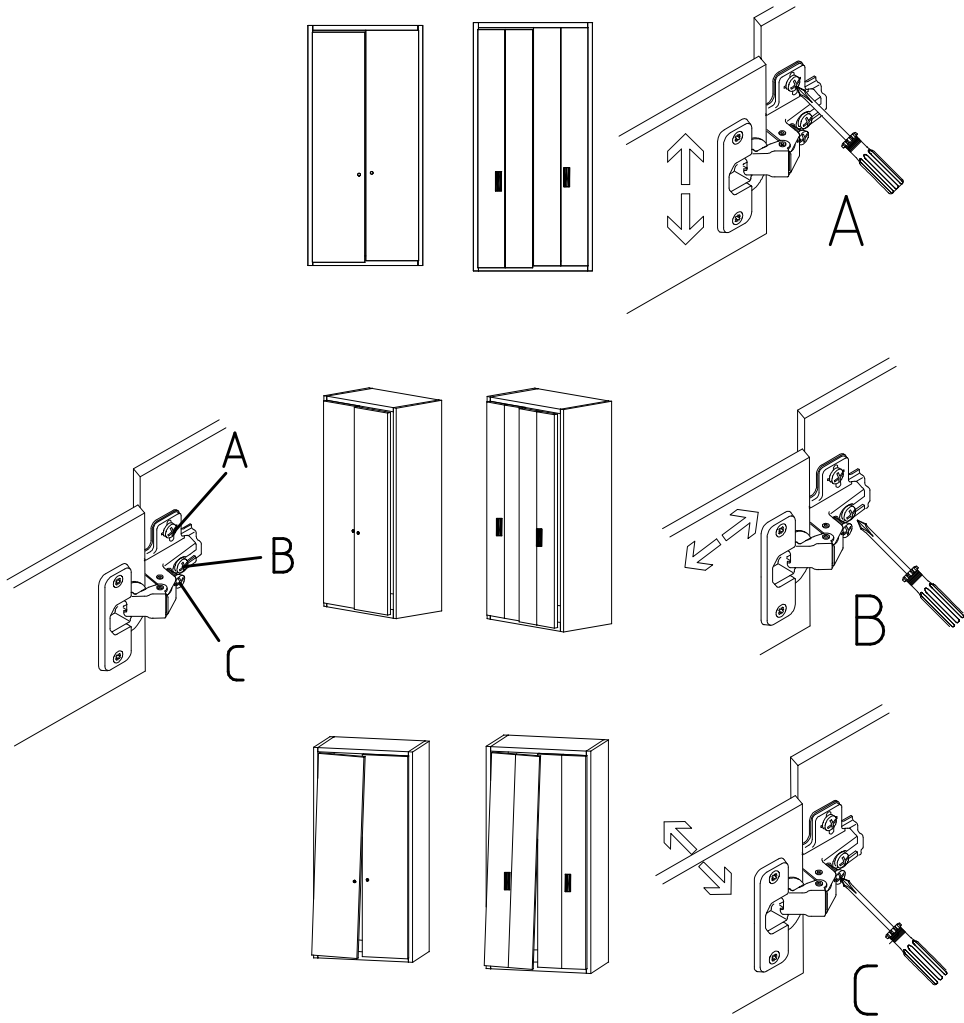

Modell/Model/Modèle

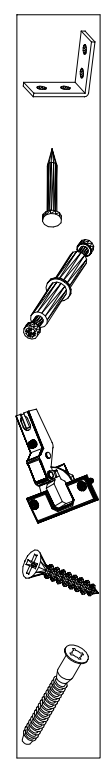
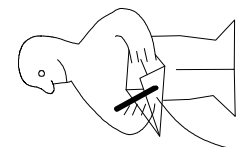
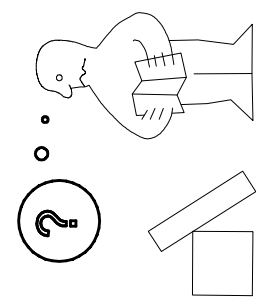
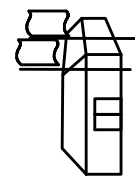
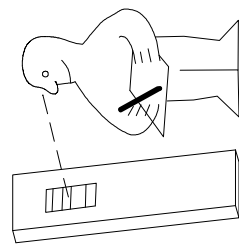

{121 370}	{ G 1 }	{4x}

Änderungen die dem technischen Fortschritt geschuldet sind, behalten wir uns vor!
 Bei nicht vorschriftsmäßiger und/ oder nicht fachmännischer Montage wird bei Personen- und/ oder Sachschäden keinerlei Haftung übernommen.
 WIMEX Wohnbedarf/ Import Export Handels GmbH/ Postfach 1407/ 49112 Georgsmarienhütte/ Germany
 Tel.:(+49) 05401 8598 16/17 Fax.:(+49) 05401 8598 33 Mail: info@wimex-wohnbedarf.de

104P-Nr. / 104P-No. 150X-Nr. / 150X-No. Auftrag/Order-No. / No. de Commande

23203 **30110XY** 104

Kunde MAX MUSTERMANN
Customer
Client

Kommission / your order reference / votre reference

3377 MINDEN

Dekor / Decor Decor / Modell / Modele

F99 **SAMPLE**

F99842 SCHWEBETUERENSCHRANK 250 CM H 216CM
PLANKENEICHE NB + RAU STEEL
PLANKENEICHE NACHBILDUNG

202320301107241476000001

Paket / Package / Paquet

414760

SOCKEL

Paket 1 von 8 Colli Kommission 10

HSP-SMT BOD 50 TEXT/TEX SOCKEL 32 FRESH TV / LF 104
SO-BOD TEXT RASTEX/ ZNBOD D18MM TX KLSTA

Montage - Anleitung Laenge 520,0 OBEREN
KS-64 Breite 568,0 OBEREN

SOCKEL32 KLEB

En cas de dommage, veuillez retourner le colis avec le carton. En cas de dommage constaté, veuillez retourner le colis avec le carton.



OBEREN 5 30/19 HAUT 23.08.19 OBEREN 1 1. JABOVE OBEREN



WIMEX Wohnbedarf
Import Export Handelsges mbH & Co. KG
Werner-von-Siemens-Str. 35
D-49124 Georgsmarienhütte - Germany

SAMPLE **23.08.19**
Modellname Produktionsdatum
Model Date of manufacture

