

Nr	Ausmaß			St	Colli
1	1935	542	15	1	2
2	1935	542	15	1	2
3	1338	85	15	2	3
4	1522	407	15	2	3
5	1160	407	15	1	3
6	1835	522	15	1	2
7	867	521	15	1	1
8	456	521	15	1	1
9	456	521	15	3	1
10	867	521	15	1	1
11	1951	70	18	1	2
12	1951	70	18	1	2
13	1230	70	15	1	3
14	1338	542	15	1	1
15	1370	542	15	1	1
16	1849	470	2	2	2
17	1849	410	2	1	2
19	859			1	1

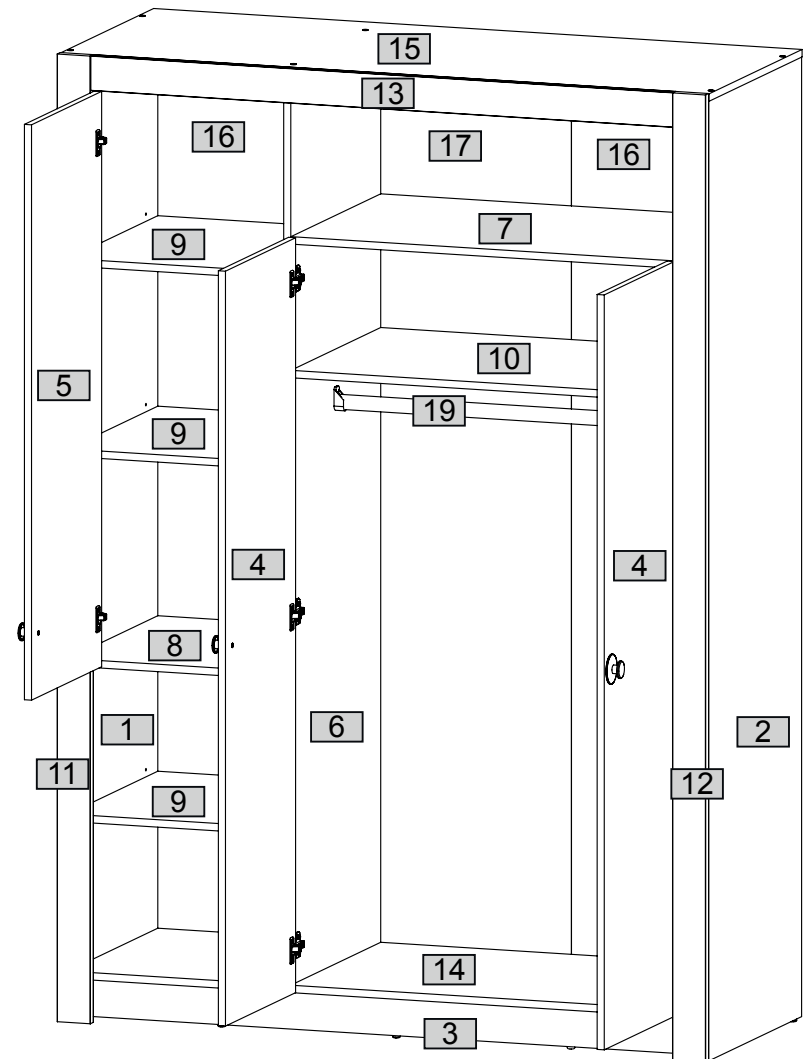

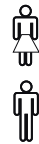

1

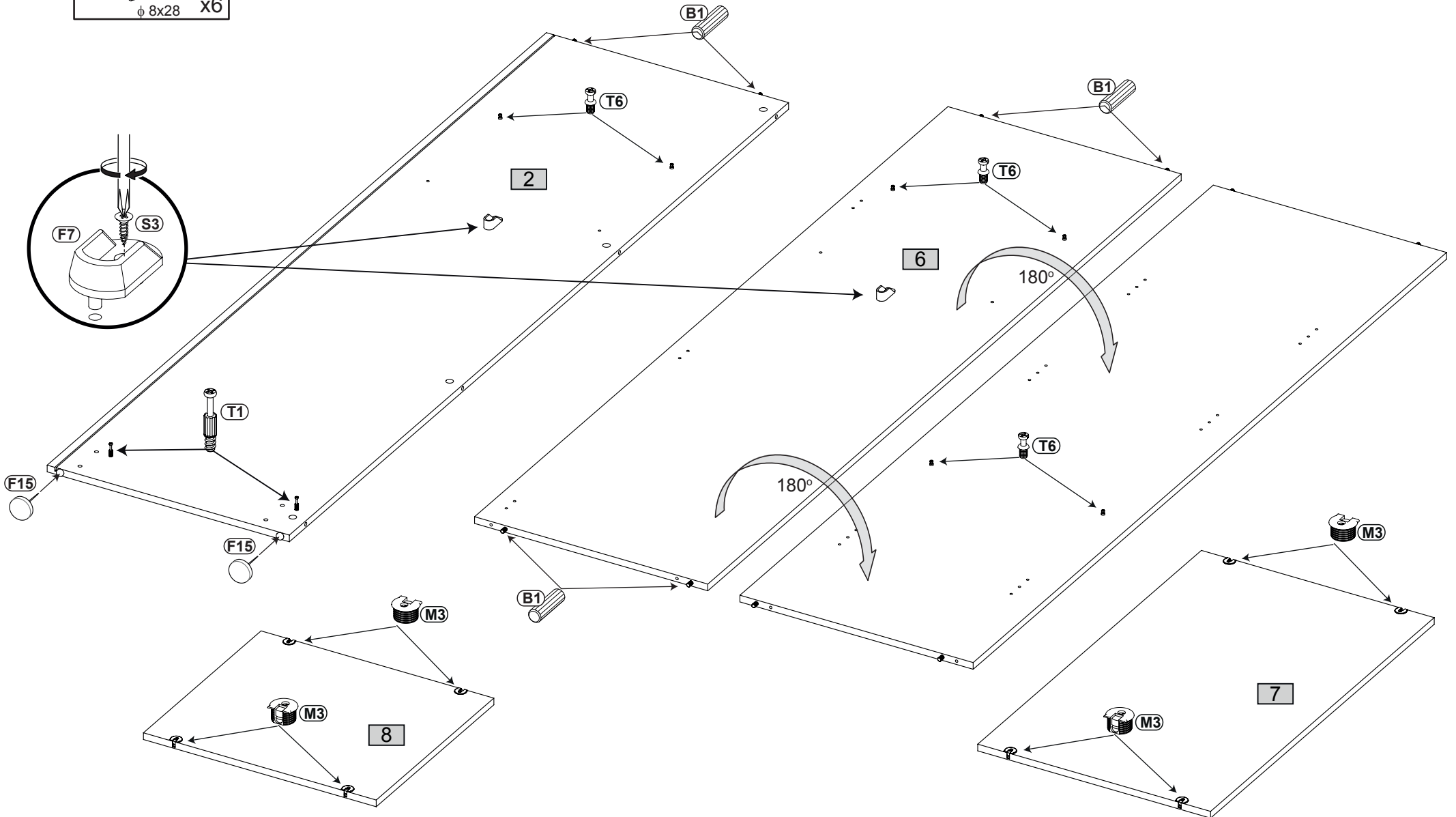
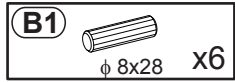
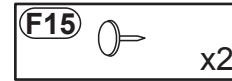
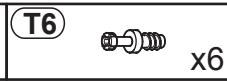
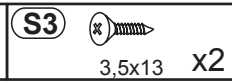
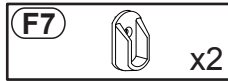
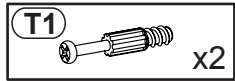

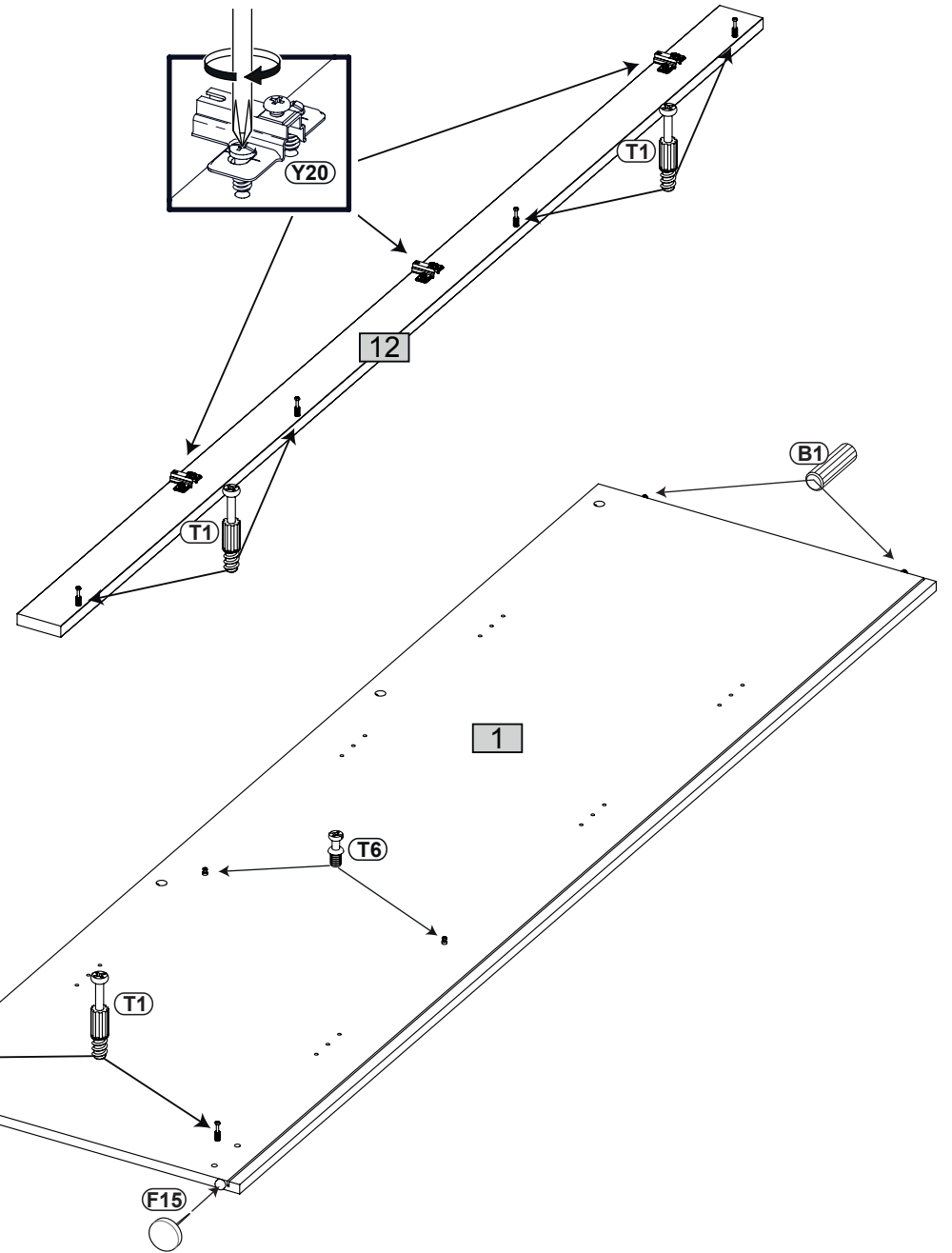
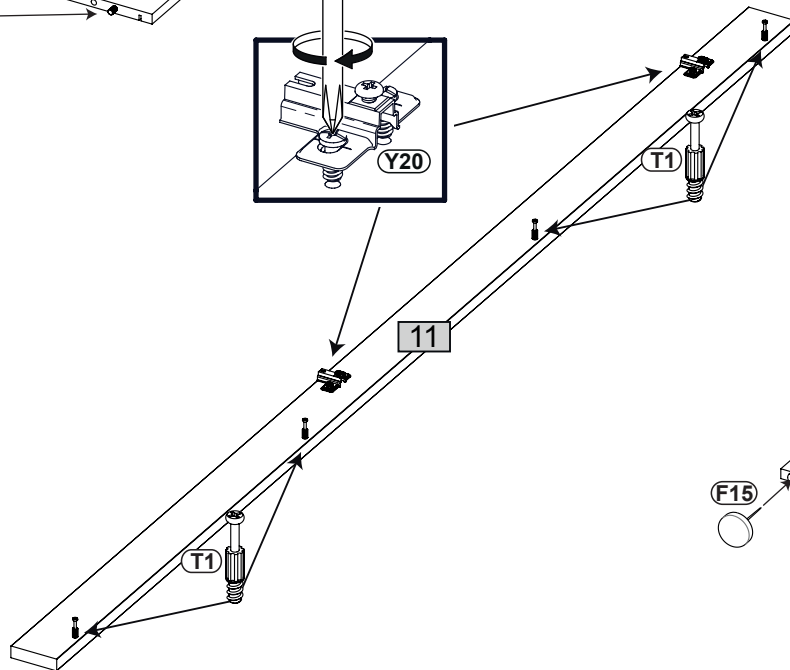
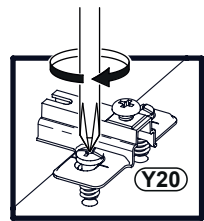
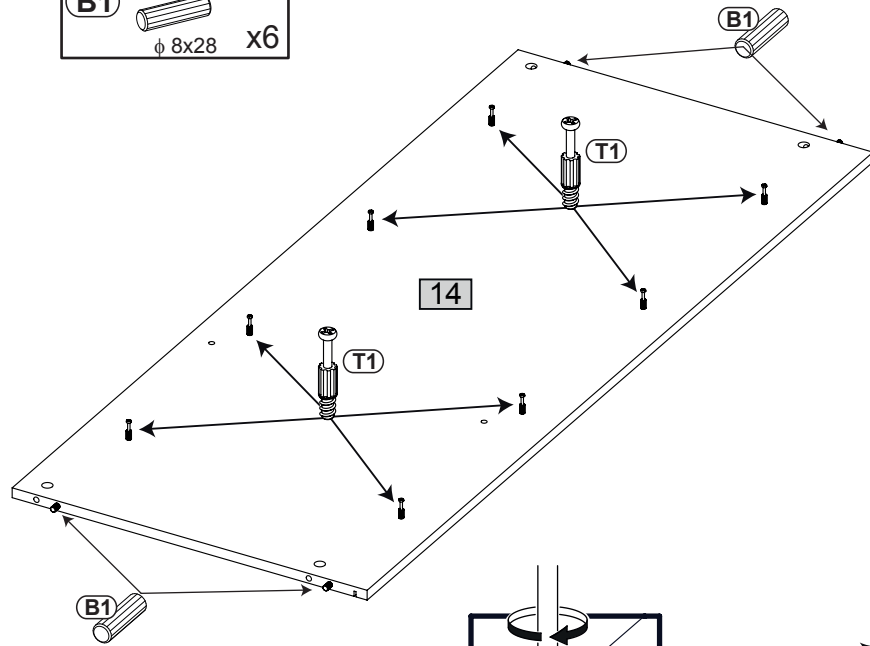
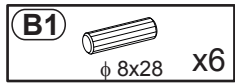
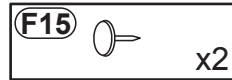
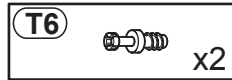
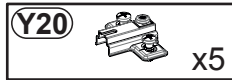
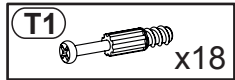
2



3

Y21  x5
Y2  KR8 x3
S8  4x13 x16

F15  x6

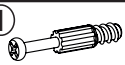
T1  x4

B1  ϕ 8x28 x8

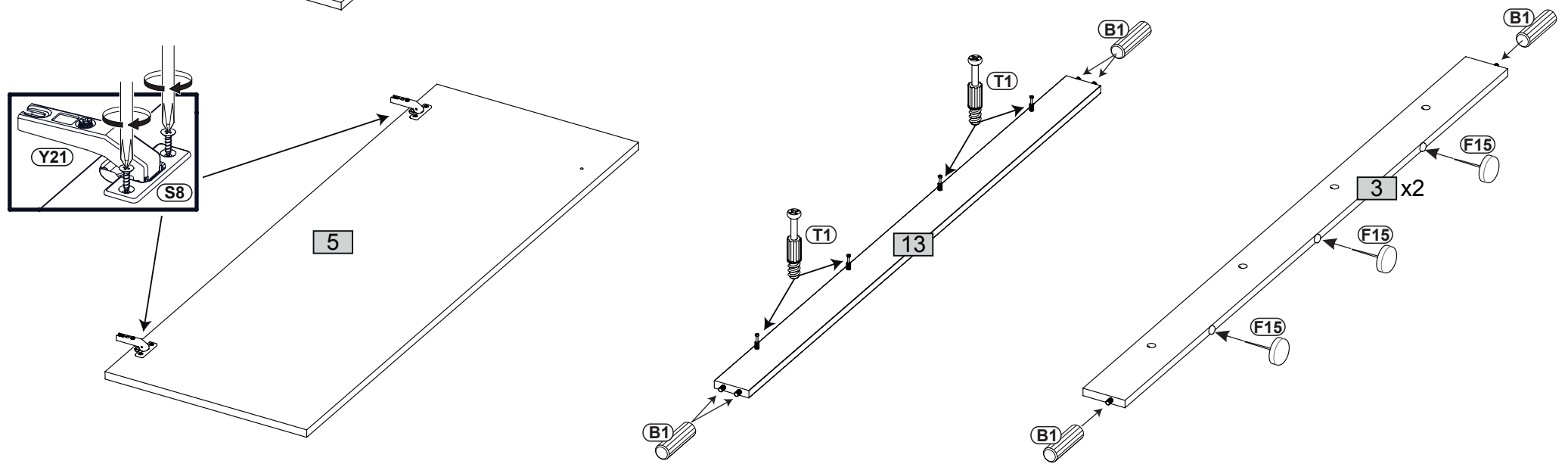
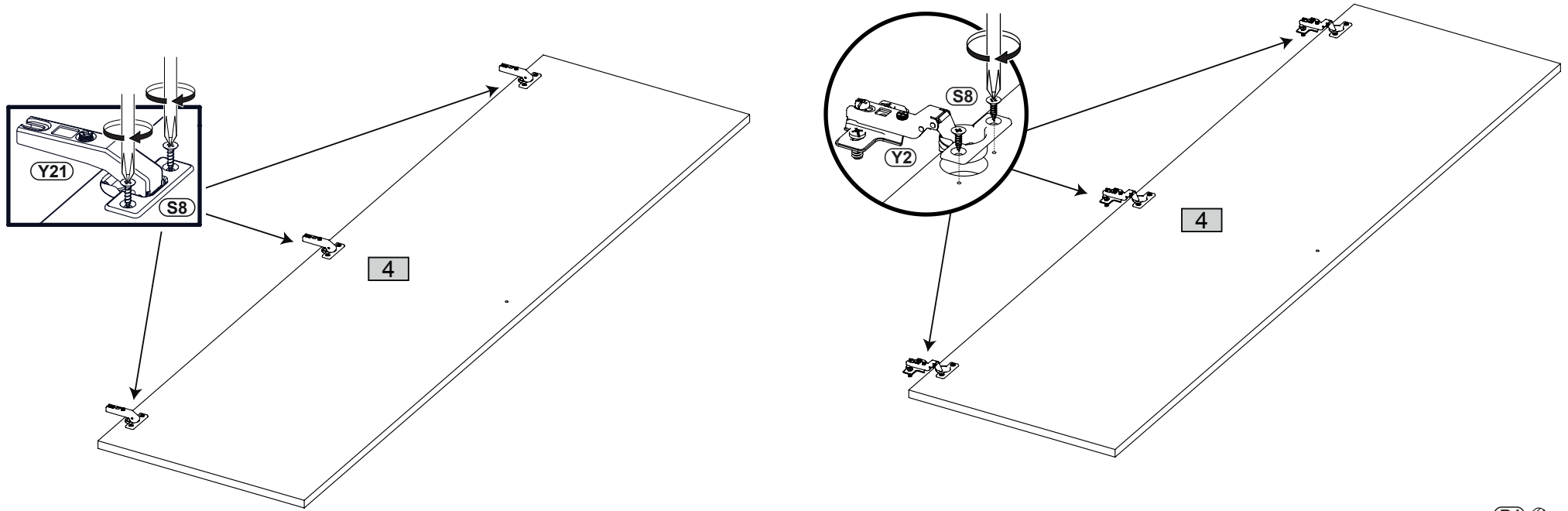

4 **M1**  x8

5 **M1**  x4

K1  7x50 x2

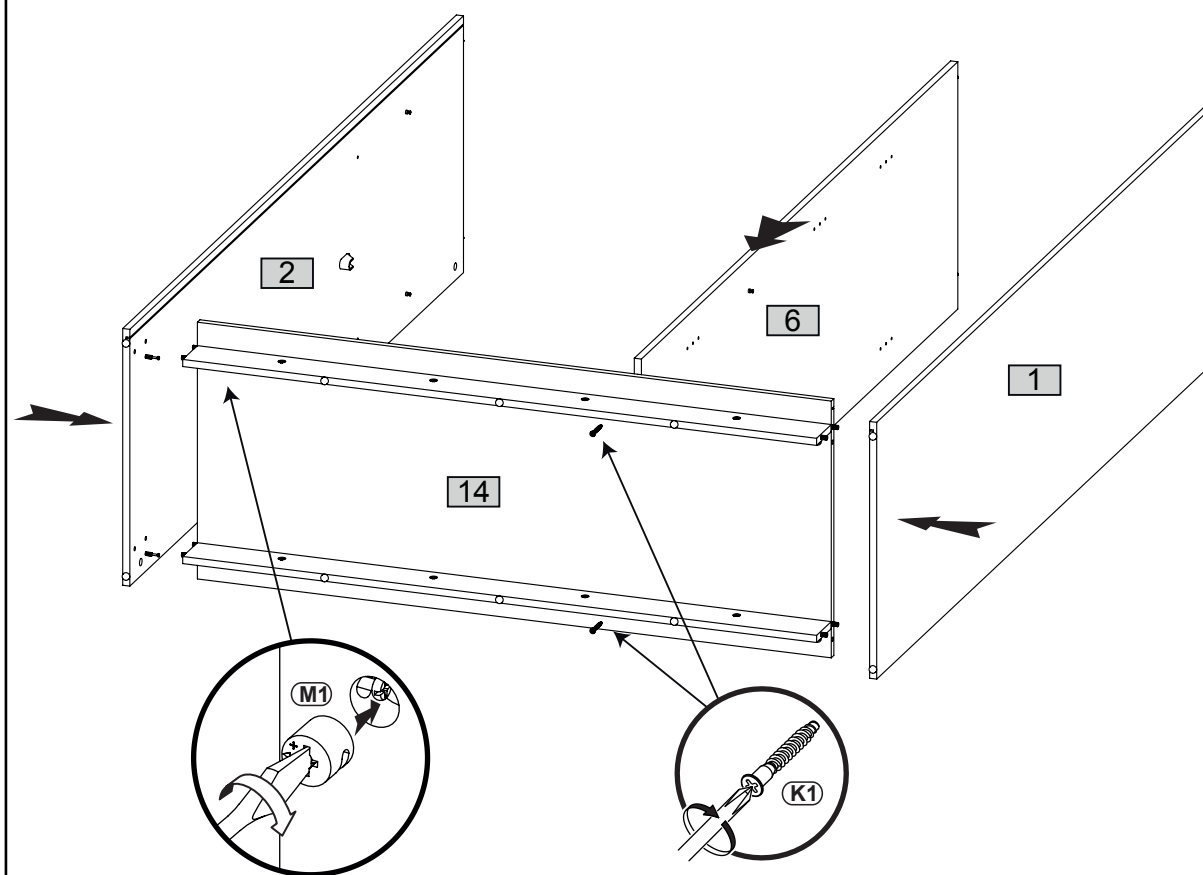
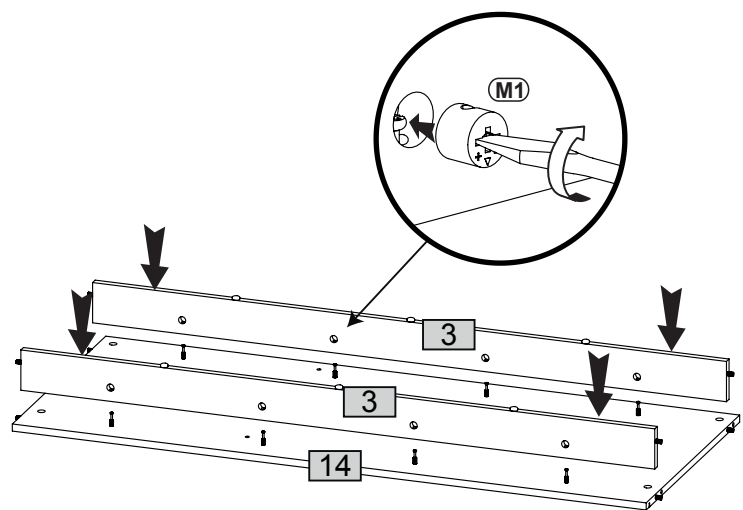

6

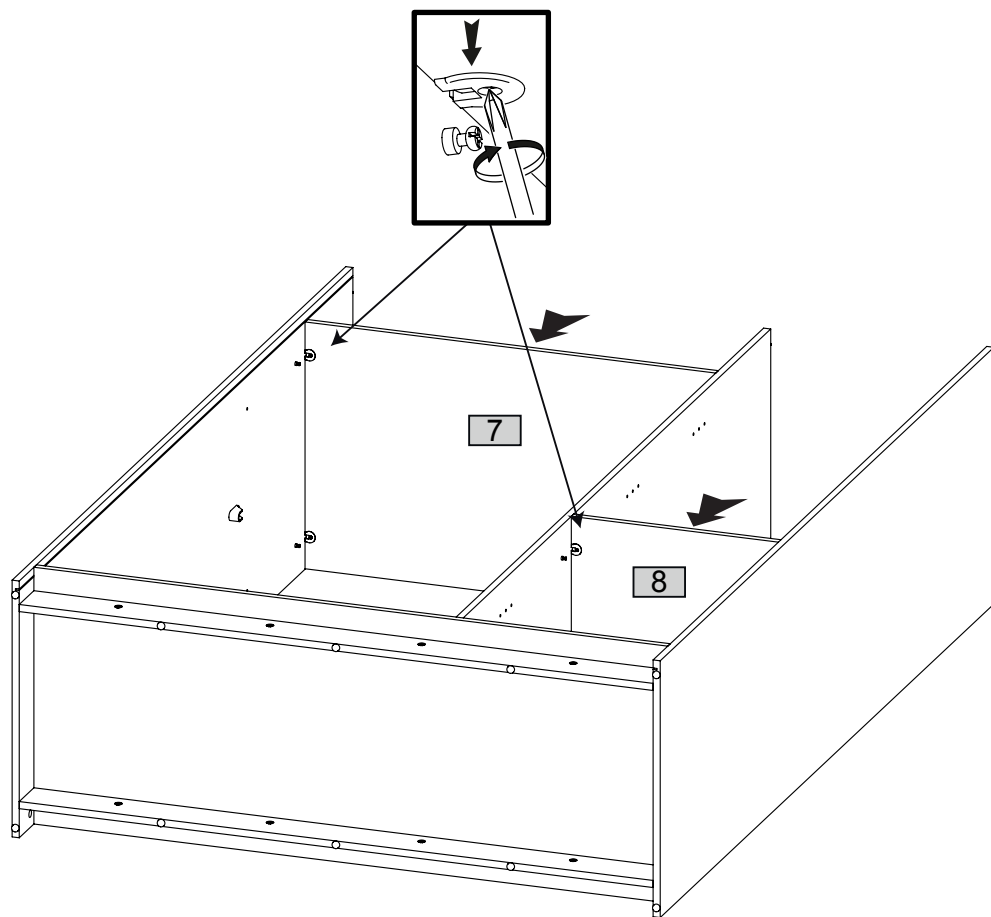

7

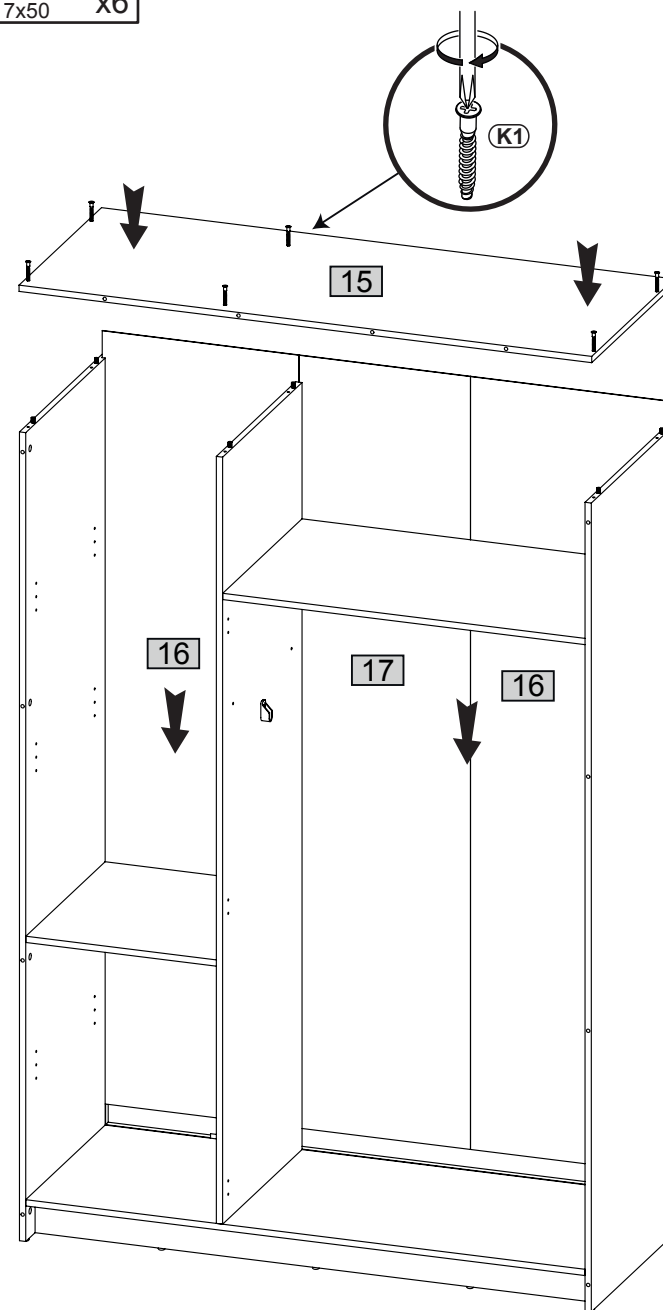
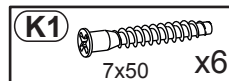

8 **M1**  x12

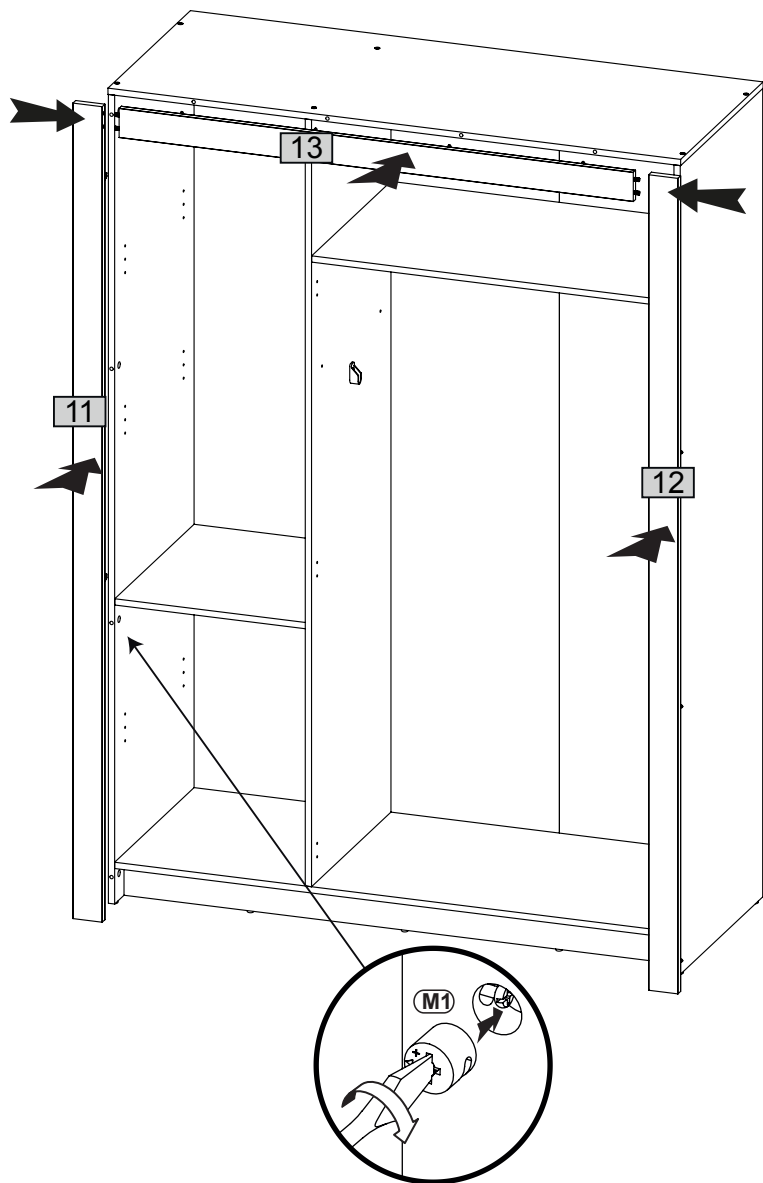

9 **F1**  x12

P2  3x16 **x21**

J23  x14

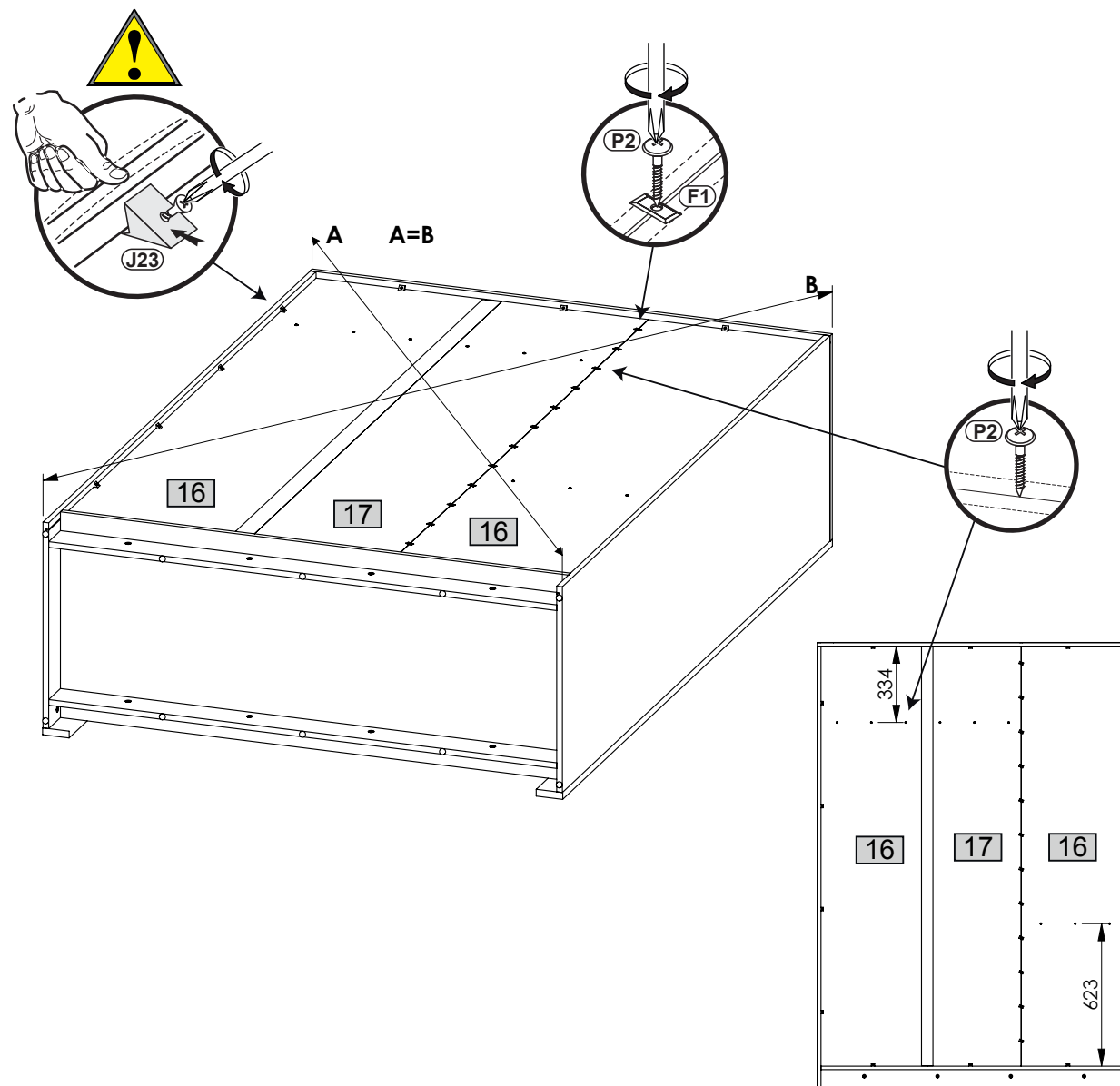

10

U33  x3

U33r  x3

U33n  x3

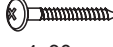
P5  4x30 x3



W1  x16

J11  x2

P13  3,5x13 x4

T17  $\phi 8 \times 50$ x2

